



SMRT SARFINDER

PRODUCT USER MANUAL

INTRODUCTION

Introduction	3
Glossary of terms & acronyms	4

HOW TO INSTALL THE DEVICE

Features	5
Installation and test components	6
Mounting of the display unit	7
Installation of the antenna	8
Electrical Connections	9-10

HOW TO USE THE DEVICE

How to use the SARfinder	11-12
How to set up	12
Display screens	13-23
Sea trial test procedure	24-25

DOCUMENTATION

Warranty	26
Disclaimer	27
Trademark notice	28
Terms & conditions of sale	28
Specification	29

INTRODUCTION

This user manual provides all the information required to operate and test the sMRT SARfinder. The following symbols and conventions are used to indicate important information. Always observe these instructions. Ensure you read the 'Warnings & safety information' section of this manual before first use of the device.



WARNINGS: Instructions that, if ignored, could result in death or serious personal injury caused by incorrect operation of the equipment. These must be observed for safe operation.



CAUTIONS: Instructions that, if ignored, could result in personal injury or material damage caused by incorrect operation of the equipment. These must be observed for safe operation.



IMPORTANT NOTES: Important instructions that should be adhered to during system operation.

TYPOGRAPHIC CONVENTIONS

1. sMRT SARfinder hardware features are displayed in bold upper-case letters e.g. **ON/OFF BUTTON**.
2. Operation status are displayed in bold upper case letters with square brackets, e.g. **[OFF]**.

USING YOUR sMRT SARfinder FOR THE FIRST TIME

Prior to first use, please ensure that you have fully read and understand the user manual and that you perform a full system test, detailed on Page 24.



WARNING: sMRT SARfinder record of ownership. As a responsible manufacturer of life saving man overboard devices, the manufacturer maintains an ownership registration database to provide contact details to Government Search and Rescue (SAR) authorities in the event of an emergency.

GLOSSARY OF TERMS & ACRONYMS

Aa

AC - Alternating Current

AIS – Automatic Identification System

Dd

DC – Direct Current

Ii

IS – Intrinsically Safe

Ll

LCD - Liquid Crystal Display

LED – Light-Emitting Diode

Mm

m - Metre

MHz - Megahertz

mm - Millimetres

MOB - Man Overboard

MRT – Marine Rescue Technologies

mW – Milliwatt

Rr

RSSI – Received Signal Strength Indicator

Ss

SAR – Search & Rescue

SCADA - Supervisory Control and Data Acquisition

Uu

USB-C – Universal Serial Bus Type-C

Vv

V – Volt

VHF – Very High Frequency radio band

Ww

W – Watt

FEATURES

- A** LCD Touchscreen Display
- B** ON / OFF button



- C** USB-C (not used)
- D** Extension loudspeaker
- E** Internal loudspeaker
- F** Power connector
- G** NMEA 0183 connector
- H** Antenna connector
- I** AIS antenna (not used)

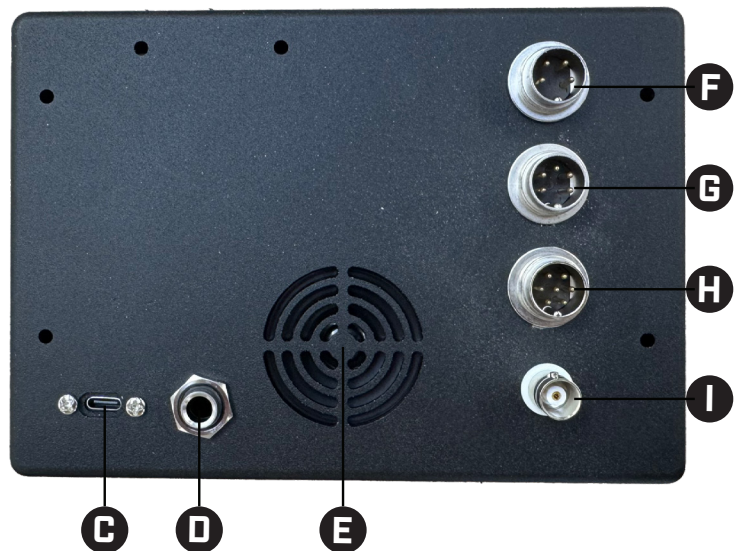

INSTALLATION & TEST COMPONENTS

MOB ALERTING UNIT TEST UNIT

A 121.65 MHz TEST beacon is included for training and exercise purposes.

The test beacon is identical to a live beacon with the exception that it will only transmit on the test frequency 121.65 MHz.

SARFINDER CONTROL BOX DISPLAY

Dedicated Man overboard alarm / locator Base Unit Automatic immediate MOB alerting and tracking.

Easy to operate and install with user friendly controls.

Approximate range indicator (near or far).

High quality construction. Training frequencies 121.65 MHz, 121.775 MHz and another programmable test frequency.

12V Power (240V AC to 12V DC or 24V DC to 12V DC converters available).

An external loudspeaker can be added for loud MOB alerting.

A siren for loud audio MOB alerting is also pre-wired to the power cable.

This can be rewired as a SCADA alarm output (see page 10).

ANTENNA

Robust lightweight antenna with mounting brackets.

Comes with 20m antenna cable as standard (other lengths are available on request), plugs, fittings and 50mm mounting bracket.

All the aforementioned components combine to create a self managed rescue system.

MOUNTING OF THE DISPLAY UNIT

MOUNTING OF THE DISPLAY UNIT

The display box can be flush mounted by cutting a hole in the mounting surface. The unit can then be mounted using the four M4 nuts and bolts provided.

The display box unit can be used with the trunnion mount adjustable bracket that it comes fitted to. It can be fixed either above head height facing down or below head height facing up.

In either case the display should be mounted on a smooth and stable surface. The back of this unit has to be accessible for power supply and RF antenna connectors. Ensure that there are no other vulnerable elements within the mounting surface (e.g. electric cables, gas pipes or water pipes).



WARNING: Note that the SARfinder must be mounted in an environment which is free from exposure to moisture. The SARfinder is not waterproof.



1. 210mm width
2. 146mm height
3. Width of bracket base 195mm (Total width including hand wheels 260mm)
4. Back section depth 65mm
5. Overall height 175mm

INSTALLATION OF THE ANTENNA

CORRECT ANTENNA POSITIONING

The position of the antenna array is of critical importance for the direction finding efficiency and effective range of the unit. The mounting position for the antenna should be as obstacle free as possible to avoid reflections and false readings. The antenna should be positioned approximately 1.5m above any other metal or antenna.

NOTE: The antenna has an 'AHEAD' sticker which must be aligned with ship's bow.

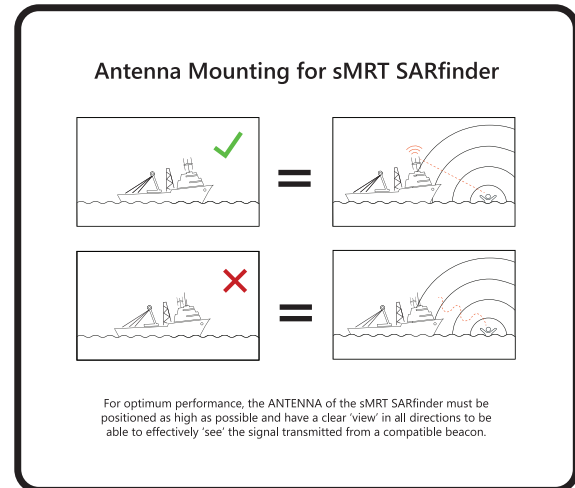

The IP66 rated antenna should be mounted on a suitable mast tube with an outside diameter of 50mm, using the supplied bracket, round silicone anti-vibration mat, M10 fixing bolts and nylon washers.

ASSEMBLY OF THE ANTENNA: WATERPROOFING THE ANTENNA - IMPORTANT

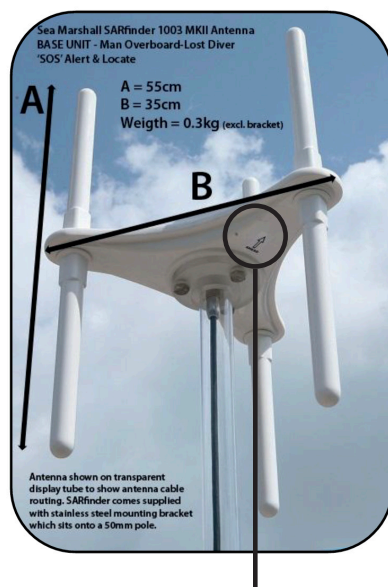

Ahead sticker

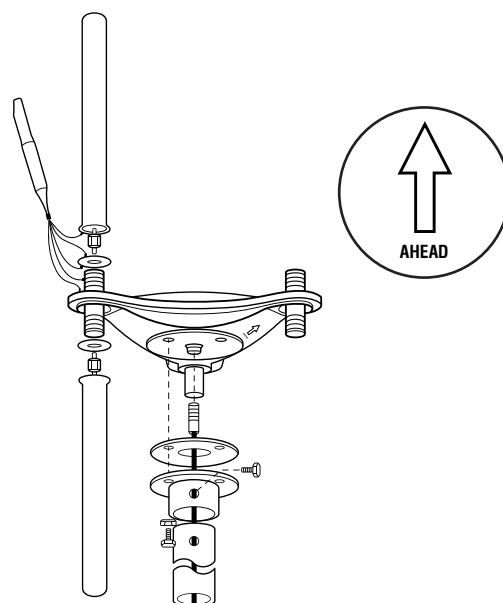

ELECTRICAL CONNECTIONS

The connections between the antenna array and display unit are routed via an MRT supplied shielded cable. Various lengths of cable can be ordered up to 50 metres. The power supply and alarm relay are also connected to the display box enclosure via an MRT supplied cable. To attach the power cable match up the 4 pin grey coloured power cable to the 4 pin connector on the back of the display box

To attach the antenna cable, align the 7 pin cable connector to the 7 pin connector on the display box, the other end matches to the connector on the underside of the antenna body.

The NMEA connector and AIS antenna connector are for future expansion. The USB-C connector is not used.

The external speaker connector takes a ¼" audio Jack socket and must be wired to an external speaker of no less than 8Ω and capable of at least 15W.

When installing the system first connect the control box to your vessel's 12V DC power supply and connect all the cables in accordance with the instructions in this manual. Test the system to check it is working correctly (see Sea Trials section). The SARfinder is protected against accidental reverse polarity. This unit will run from a 12V DC power supply only, if your power supply is 24V DC or 120/240V AC you will need to install a step down transformer or converter (available from MRT Ltd.).

If the power supply on your vessel is unreliable, install an isolated power supply. The manufacturer cannot be held responsible for damage caused by wiring the unit into an incorrect power supply. Your warranty does not cover this.

WIRING FOR POWER PLUG

PIN	CABLE FUNCTION
1	Relay Contacts
2	0V DC Negative
3	12V DC Positive
4	0V DC Negative

APPROX POWER CONSUMPTION FOR SARfinder

ON - 500 mA

ALARMING - 1200 mA¹

TRACKING - 550 mA



IMPORTANT NOTE: 2000 mA if an 8Ω external speaker has been fitted.

EXTERNAL SIREN ALARM CABLE

This cable is supplied with a small, very loud external siren pre-wired onto the power cable.

This siren must be fitted if you are to rely on the SARfinder to raise the alarm by means of an audio alert and you have not connected an external speaker. When a 121.5 MHz beacon is detected an internal relay closes to trigger external circuits.

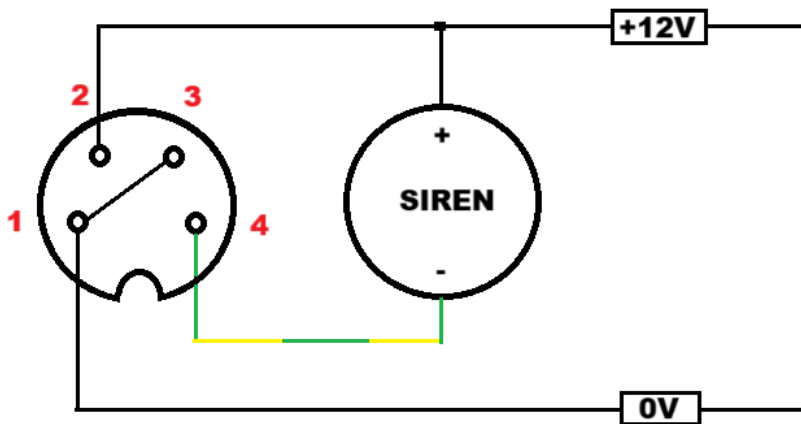

EXTERNAL SCADA ALARM CABLE

It is possible to connect the SARfinder to other external alarms such as a SCADA alarm. The cable this is supplied with 4 wires, two for DC power and two for volt-free alarm connection. It is recommended to connect an external loudspeaker if using the alarm output for other than connection to a siren.

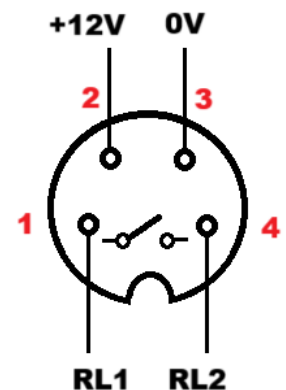

HOW TO USE THE SARfinder

- STEP 1:** Switch on - Press the **ON / OFF BUTTON** and wait for the display box to boot up. The power LED goes out as soon as the button is pressed. When the unit is off the LED is lit to allow the button to be found in the dark.
- STEP 2:** By default the SARfinder will tune to live channel (121.5 MHz) and be listening for a down-swept tone distress signal.
- STEP 3:** If you want to change the channel your SARfinder is on, touch the settings symbol. Then touch <monitoring frequency> and select a new frequency.



IMPORTANT NOTE: After an hour of operating on a channel other than 121.5 MHz, the SARfinder will jump back to 121.5 MHz. It will not remain on test channel indefinitely.

- STEP 4:** When an SOS Signal is received, the alarm will trigger and the screen will flash.
- STEP 5:** Touch the screen anywhere, this will cancel the alarm and put the SARfinder in to tracking mode. Your unit will now display the direction to the SOS signal.
- STEP 6:** Bring the vessel around so the SOS direction is dead ahead. When the bearing to target is within $\pm 40^\circ$ the direction indicator will be green, otherwise it will be red.
- STEP 7:** Check the Received Signal Strength Indicator (RSSI) to see if the signal is near or far.
- STEP 8:** Move towards the target checking the RSSI. When the target is very close and all four RSSI indicators are illuminated, slow the vessel down to a couple of knots.
- STEP 9:** A STOP indicator will begin to flash when the target is within approximately 100-200 feet of the vessel.
- STEP 10:** Steer around the target and prepare your crew to recover the target.
- STEP 11:** Recover the target, switch **[OFF]** the beacon and repeat as required for the next target.

If for any reason you are unable to affect your rescue using the SARfinder, contact the Coast Guard and tell them you have a man in the water wearing a 121.5 MHz beacon. For the BASIC Test / Checking the SARfinder system before first use, see the Sea Trials section of this manual.



WARNING: Please ensure correct shutdown procedure is performed on the SARfinder before disconnecting the mains power. To do this press the standby button and follow the onscreen instructions. Failure to do this may result in product malfunction.

HOW TO SET UP THE DEVICE

The procedure below indicates how you should set up the device so it is ready for use.

1. Plug the power cable into the top socket located on the rear of the device.
2. Plug the antenna cable into the third socket on the rear of the device. This is located just below the NMEA socket.
3. Once a power source is connected, the power button on the front of the device will light up to help locate the button when dark on the bridge. This indicates that the device is **[OFF]**.
4. To turn on the device press the power button. The screen will then load up with the home screen.

DISPLAY SCREENS

The below shows how to operate the sMRT SARfinder and what each screen does.

1. HOME SCREEN



The home screen is the first screen that you will see when starting the device. It acts as the main access point to all of the different screens you will use.

- 1. Settings:** To view system settings touch the **COG BUTTON**. It will then open up the menu screen where you can manually change settings.
- 2. Direction Finder:** To enter the direction finder screen you need to touch the triangular **COMPASS BUTTON**.
- 3. Wi-Fi:** The Wi-Fi signal strength will be displayed through the Wi-Fi symbol located in the top right of the screen. The symbol will only show if the Wi-Fi is turned on and if it's not connected to the internet then the symbol will disappear. This is only a visual reference and not a button shortcut. Wi-Fi settings can be found in the main settings menu.

2. SETTINGS MENU

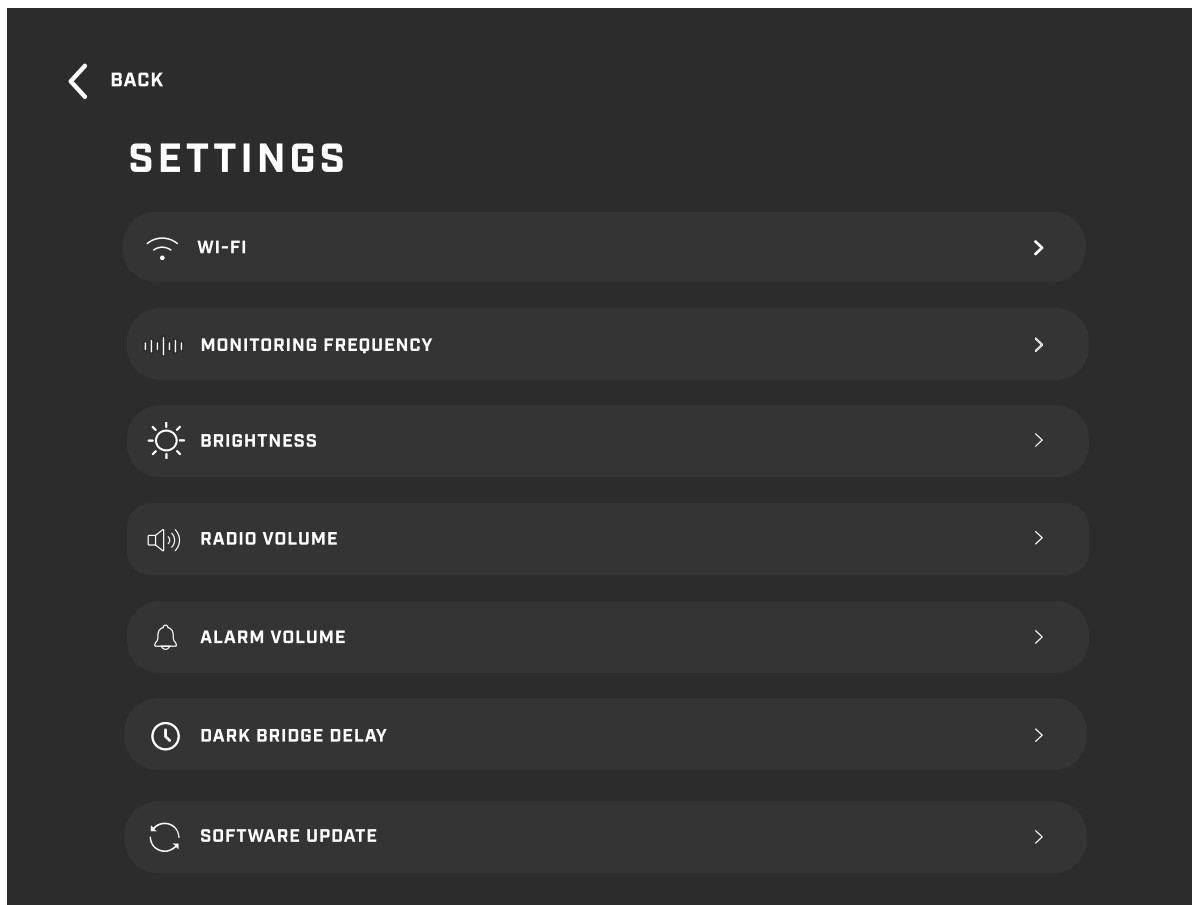

After touching the **COG BUTTON** on the home screen you will be directed to the settings main menu screen. Here you will be able to open each section:



Wi-Fi



Alarm Volume



Monitoring Frequency



Software Update



Brightness



Dark Bridge Delay



Radio Volume

3. WI-FI SETTINGS



IMPORTANT NOTE: Wi-Fi is only used for updating the SARfinder's internal firmware. It is not needed for normal operation and need not be set up. If the Wi-Fi is not setup the Wi-Fi symbol on the home screen will disappear.

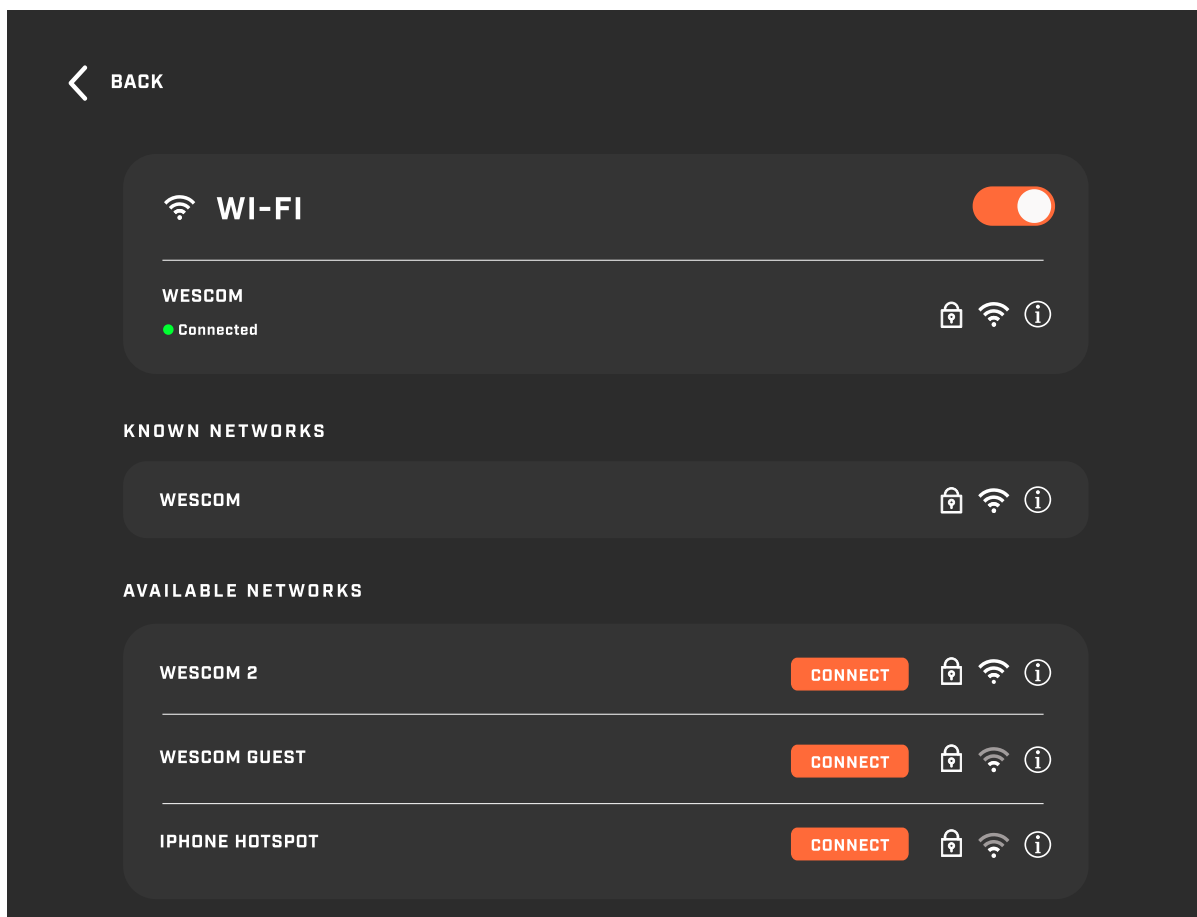

CONNECTED DEVICES

If paired to a network, it will be displayed in the header tab under 'WI-FI'. This is demonstrated with a green circle next to the Wi-Fi network name. If it's not connected to any networks then it will have a red circle and say 'Not connected'.

KNOWN NETWORKS

If you have previously connected to a network, it will be stored in the 'Known Networks' section. An orange **CONNECT BUTTON** will be visible and available to touch. This will then switch you to that network. You may switch back whenever.

OTHER NETWORKS

Networks that haven't previously been connected to the device will be listed in the 'Other Networks' section. To connect to the network touch the **CONNECT BUTTON** and you will be taken to the password screen, which you will be required to enter the network password.

NETWORK INFORMATION

When touching on the network **INFORMATION BUTTON** it will direct you to the above screen. This is where all the network information is stored. You can also select whether you wish the device to auto connect to the network by touching the **AUTO JOIN TOGGLE**. You may also choose to remove the network by touching the **FORGET THIS NETWORK BUTTON**. If you later wish to re-join the network then you will be required to re-enter the password.

The screenshot shows a network configuration screen for a network named 'WESCOM'. At the top left is a back arrow and the word 'BACK'. The network name 'WESCOM' is displayed in the top left, and an 'AUTO JOIN' toggle switch is in the top right, which is currently turned on. Below the network name is a 'PASSWORD' field with a masked password of ten dots. Underneath is the 'IPV4 ADDRESS' section, which contains a table with the following information:

CONFIGURE IP	AUTOMATIC
IP ADDRESS	192.168.1.217
SUBNET MASK	255.255.255.0
ROUTER	192.168.1.1

At the bottom of the screen is a large red button labeled 'FORGET THIS NETWORK'.

4. MONITORING FREQUENCY

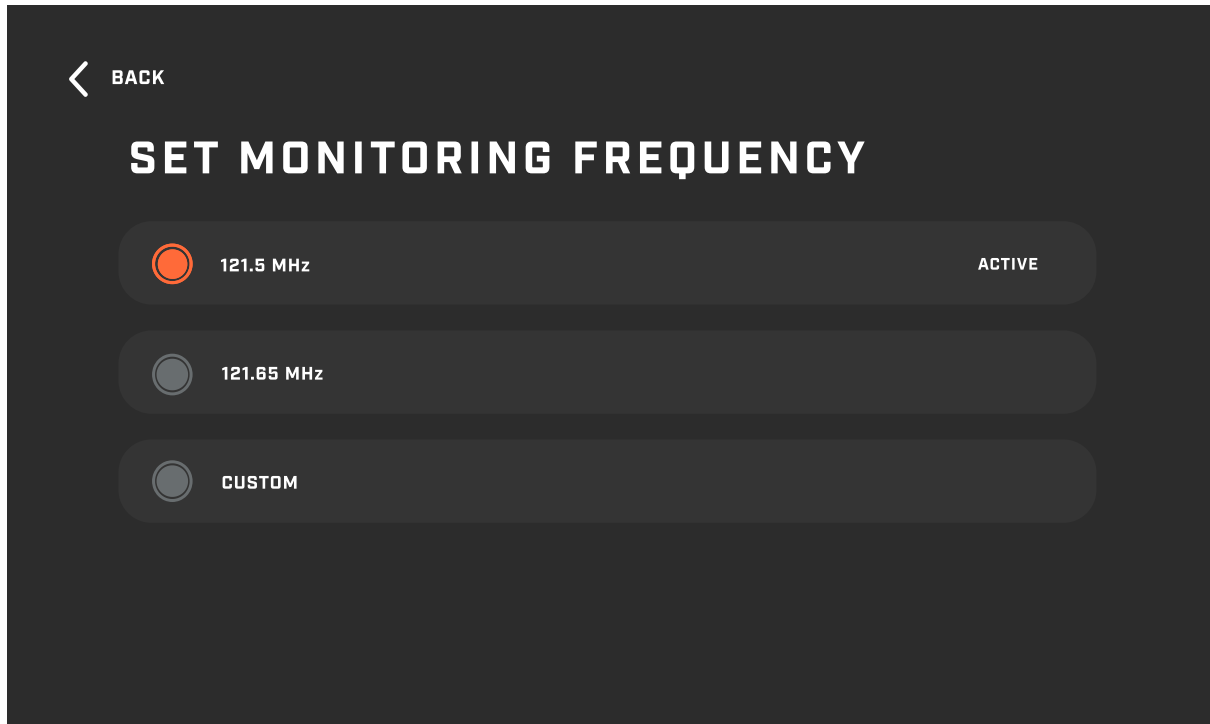

You may select, which frequency you wish the device to operate on. Once selected, the frequency will show as 'ACTIVE' and the radio button will turn orange.

121.5 MHz is the default setting and will automatically be activated when first using the device. You may change frequency at any time to 121.65 MHz or to a custom frequency. However, please note that it will automatically switch back to 121.5 MHz after 1 hour and after restarting the device.

If you choose to select a custom frequency, you will be prompted to enter the required number, which must be between 118.000 MHz and 138.975 MHz. Before entering, the placeholder frequency will be defaulted to 121.775 MHz.

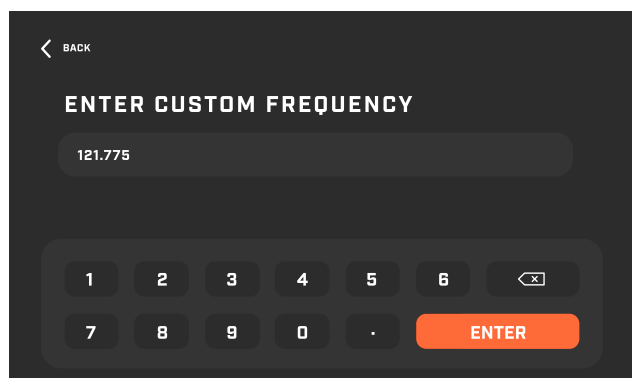

5. BRIGHTNESS, VOLUME, DARK BRIDGE DELAY

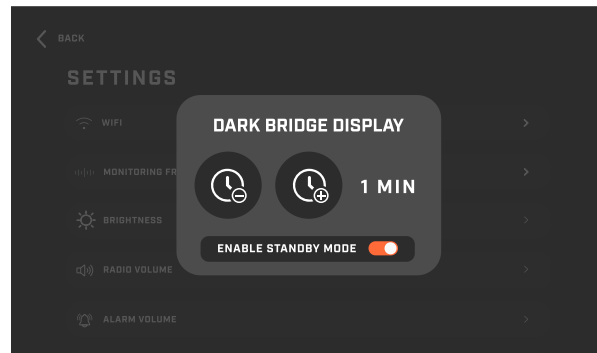
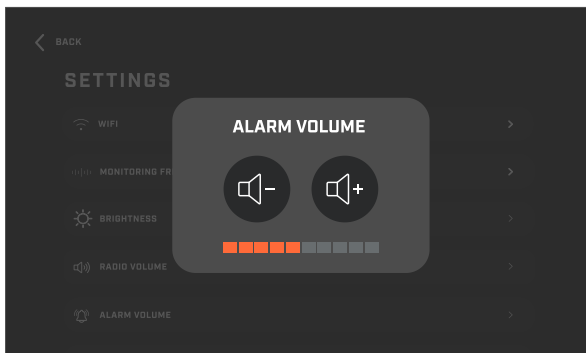
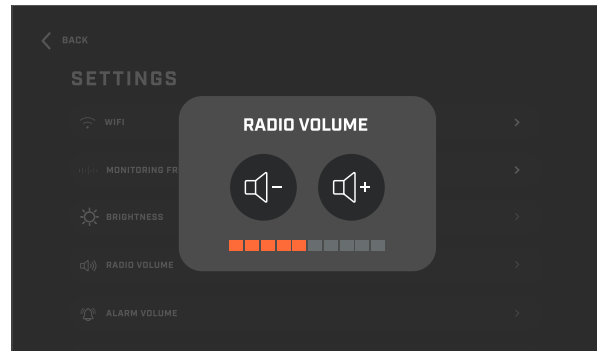
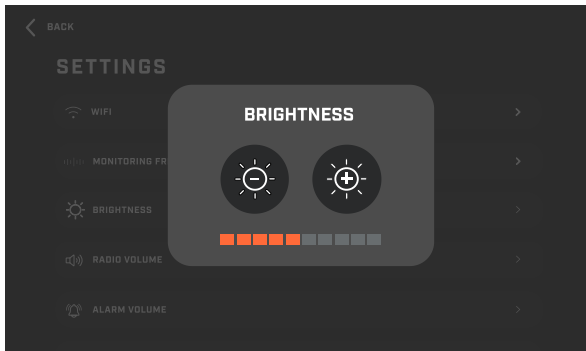

Brightness

When touching the **BRIGHTNESS BUTTON** on the settings menu, a pop up will appear. Touch the plus and minus button to adjust the brightness accordingly.

Radio Volume

When touching the **RADIO VOLUME BUTTON** on the settings menu, a pop up will appear. Touch the **PLUS / MINUS BUTTONS** to adjust the brightness accordingly. A beep will sound with each press to indicate the loudness.

Alarm Volume

When touching the **ALARM VOLUME BUTTON** on the settings menu, a pop up will appear. Touch the **PLUS / MINUS BUTTONS** to adjust the brightness accordingly. A beep will sound with each press to indicate the loudness.

Dark Bridge Delay

Dark Bridge Delay allows you to set the timer (in minutes) for when the screen will either go dark or start the screen saver. Touch the **PLUS / MINUS BUTTONS** to adjust the delay accordingly. Touch the **TOGGLE BUTTON** to switch between dark bridge and screen saver mode.

6. SOFTWARE UPDATE

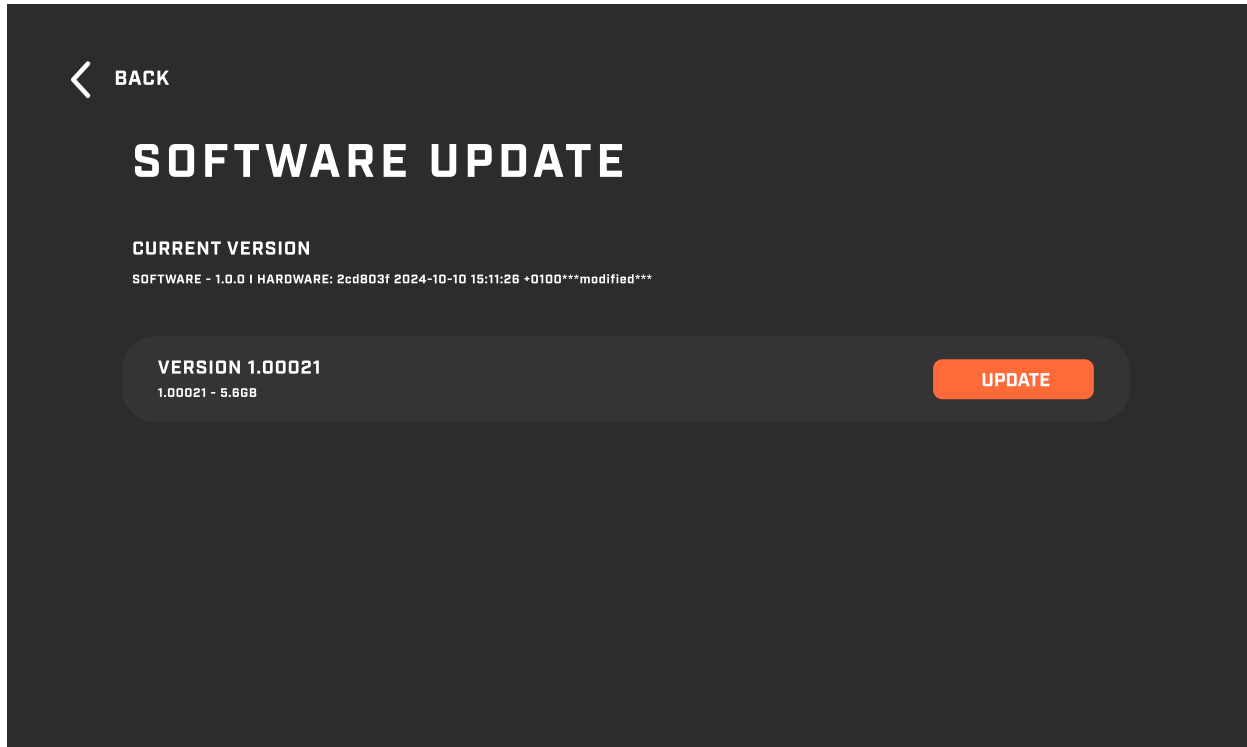

You can check that your device is up to date by touching the **SOFTWARE UPDATE BUTTON** in the settings main menu. The current version that your device is using will be listed under the title section.

If an update is available, and the SARfinder is connected to Wi-Fi, then it will show along with the version number and details an orange **UPDATE BUTTON**. Touch this to download the latest software version. Initially the screen will display 'Checking for updates' until updates are found.

7. DIRECTION FINDING

In the event of an MOB alert the sMRT SARfinder will activate the alarm. When alarming, the screen will flash and touching it anywhere will silence the alarm and switch to the tracking screen.

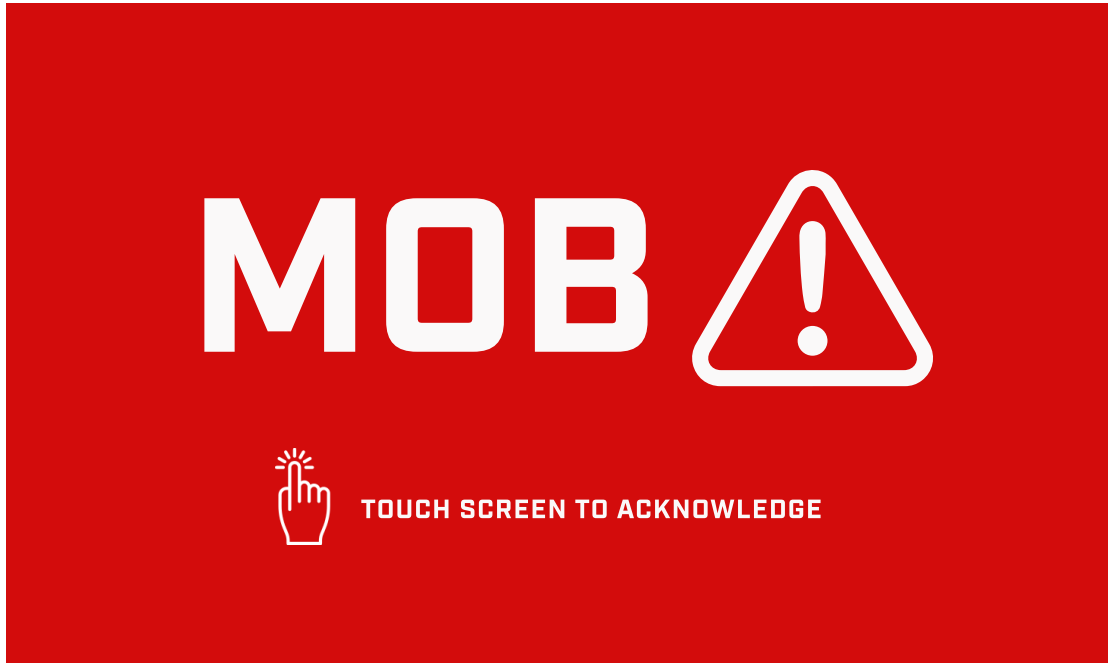

The tracking screen shows a compass aligned with the ship's current heading. Bearing to target is indicated by a red or green arrow. When the bearing to target is within $\pm 40^\circ$ of the current heading, the direction indicator will be green, otherwise it will be red. Use this screen to navigate to the MOB. This screen can also be accessed at any time by touching the triangular compass icon on the home screen.



IMPORTANT NOTE: When performing a test please note that the alarm will have a different tone to that of a live alert.

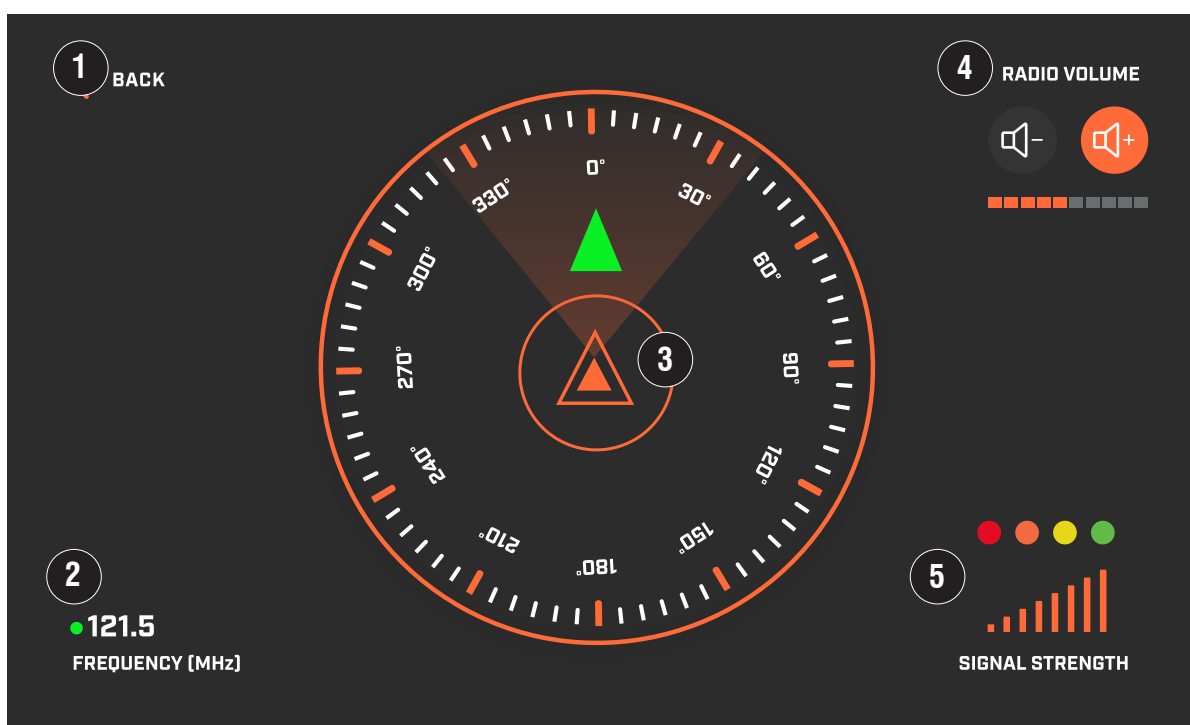

- 1. Return to home screen:** You can return to the home screen at any time by touching the **BACK BUTTON**.
- 2. Frequency:** The frequency the SARfinder is operating on is displayed here.
- 3. Compass:** The compass is your guide to locating the MOB. The wheel will turn to coincide with the movement of the vessel so the helmsman can line themselves up with the person. The smaller triangle will remain red until the helmsman goes in the correct direction. To acknowledge this, the triangle will turn green and sit in the light beam at the top of the wheel.

- 4. Radio Volume:** In addition to the settings menu, you can also find a radio volume shortcut. This allows the user to adjust the radio to the required volume. A beep will sound to indicate the loudness on each touch.
- 5. Signal Strength:** The signal strength is displayed through a traditional bar system. As the signal increases the numbers of bars shown in orange will increase. Alongside this is a traffic light system with red meaning weak signal and green meaning strong signal.

When in close proximity to the person in the water, a warning message will display on screen advising to stop the engines. Stopping the propeller from rotating ensures that the person in the water won't be accidentally injured by them. The rescue operation can then be safely carried out.



8. POWER OFF / RESET DEVICE

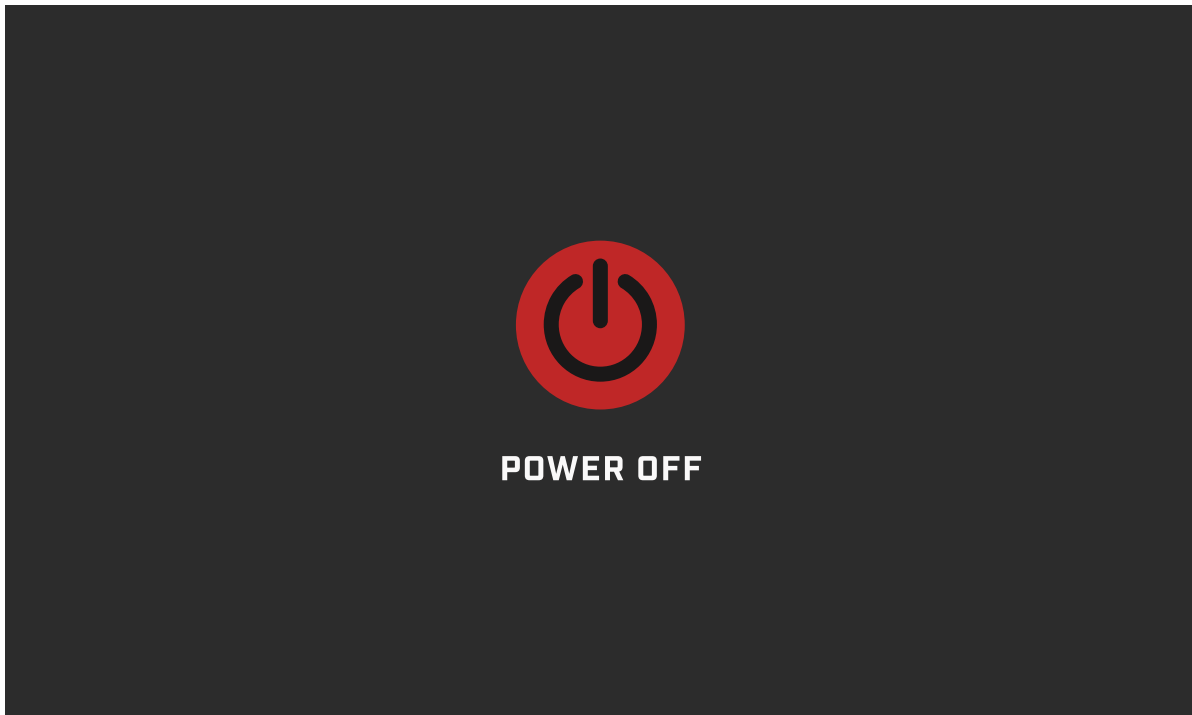

To turn the device off, simply press the **ON / OFF BUTTON**. This will then bring up the above screen. Touching the on-screen **POWER OFF BUTTON** will switch the SARfinder off. To dismiss this screen and return to the previous screen just tap anywhere in the empty space.

In the unlikely event that SARfinder freezes or crashes a hard reset can be initiated by pressing and holding the **ON / OFF BUTTON** for more than 5 seconds.



IMPORTANT NOTE: If the DC supply voltage is low, a warning message will appear above the **POWER OFF BUTTON** showing the DC supply voltage level. This will only occur if the voltage is less than 8V, and will stay on screen for approximately 4 seconds before disappearing. This will then repeat 3 times and if no action is taken, the SARfinder will shut down itself.

SARfinder SEA TRIAL TEST PROCEDURE

Each SARfinder is taken through a series of tests before it is signed off ready for dispatch from the factory. These test: system accuracy, signal strength check, system function check/alarm activation. These tests are performed as follows:

1. In house test on simulator to simulate different ranges and transmitted power.
2. Outdoor test over a 2.2 mile range at 0.5, 1.0 and 2 miles using a 100 mW beacon.

It is recommended that a 'set' test and training procedure is carried out at sea at regular intervals to familiarize crew members with the operation of the system.



IMPORTANT NOTE: Your SARfinder has been calibrated and tested using the antenna and cable supplied with it. Using the display box with a different antenna or different length antenna cable will result in sub-optimal performance and may invalidate the warranty.

SEA TRIAL PROCEDURE

1. Make sure that the test beacon supplied with your SARfinder is fitted to a life jacket or marker buoy and a weight added so that the life jacket/buoy allows the antenna to be positioned at an angle of between 45 and 0 degrees from vertical. Also make sure the beacon's batteries are in good condition.
2. Switch on the SARfinder - Press and hold the **ON/OFF BUTTON**.
3. Change the channel by touching the settings symbol. Then touch <monitoring frequency> and select 121.65 MHz.



IMPORTANT NOTE: After an hour of operating on the test channel the SARfinder will switch back to 121.5 MHz automatically. It will not remain on test channel indefinitely.

4. Arm and activate the test beacon and throw the life jacket overboard.
5. When an SOS Signal is received the SARfinder will sound the alarm.

6. Touch the screen anywhere after the alarm has sounded, this will cancel the alarms and put the SARfinder into tracking mode. Your unit will now begin displaying a bearing to target as well as the RSSI of the received signal.
7. Bring the vessel about so that the SOS direction is dead ahead, check the direction bearing in relation to the position of the test beacon
8. It's advised to repeat the process at ranges between 0.5 and 5 miles (depending on your SARfinder antenna height and therefore the distance to the horizon). This will allow you to gain confidence in the operation of your system.



IMPORTANT NOTE: Range and performance will vary according to placement of the antenna, sea state, weather conditions and distance to the horizon.

9. After trials recover the test beacon from the water and switch it off.

WARRANTY

Your sMRT SARfinder is covered by a warranty against manufacturing defects in materials and workmanship for a period of 1 year from the date of purchase in accordance with the following conditions:

- Marine Rescue Technologies Ltd reserves the right to repair or replace a faulty product at its discretion, free of charge, excluding shipping costs.
- A valid proof of purchase from the original buyer is required for warranty claims.
- Claims must be submitted in writing to Marine Rescue Technologies Ltd or an approved service partner. A list of servicing partners can be found at smrtsos.com.

Marine Rescue Technologies Ltd is not liable under the warranty for:

- Repairs or modifications performed on the product using non-approved parts or by entities other than Marine Rescue Technologies Ltd or approved service dealers, a full list of approved dealers can be found on the sMRT website, smrtsos.com.
- Parts, materials, or accessories not manufactured by Marine Rescue Technologies Ltd; in such cases, the consumer will be covered by the guarantee/warranty offered to Marine Rescue Technologies Ltd by the manufacturer or supplier.
- Unpaid products or those under alternative warranty agreements.

This warranty does not impact your statutory rights. The interpretation of this warranty is under English law. Please ensure you have fully read and understand the User Manual.

For further assistance, please reach out to our service department.
Email: smrt@wescom-group.com

DISCLAIMER

The sMRT SARfinder should not be relied on as the only source of man overboard notification and the vessel owner, operator or master must exercise common prudence and good seamanship at all times. Use of the sMRT SARfinder in no way reduces liability of the vessel's master and crew who have the primary responsibility for safety on board.

This user manual contains important information that must be adhered to for reliable use and operation of the product. It is the owner's sole responsibility to make the effort to read this manual and to ensure that the equipment's operation and limitations are understood. Visit the manufacturer's website www.smrtsos.com to download the latest user manuals for all products. The manufacturer reserves the right to change specifications, equipment, installation and maintenance instructions without notice as part of the company's policy of continuous product development and improvement.

TRADEMARK NOTICE

Marine Rescue Technologies Limited, is the 100% owner of Marine Rescue Technologies Limited in the United Kingdom.

The absence of a product or service name or logo from those listed does not constitute a waiver of Marine Rescue Technologies Limited's trademark or other intellectual property rights concerning that name or logo.

Other product names mentioned within this document may be trademarks or registered trademarks, or a trade name of their respective owner. Contact Marine Rescue Technologies at mrtcustomerservice@wescom-group.com for a copy of our trademark policy before referencing or using any trademark or product name.

© Marine Rescue Technologies Limited 2024. All rights reserved. No part of this publication may be transmitted or copied in any form whatsoever, without the express written permission of Marine Rescue Technologies Limited.

TERMS & CONDITIONS

Please visit www.smrtsos.com/terms-conditions to view our terms & conditions.

SPECIFICATION

CONTROL BOX	
CONTROL BOX DIMENSIONS	175 x 120 x 65mm — Aluminium Box (excluding antenna & connectors)
CONTROL BOX WEIGHT	1200gms
MOUNTING OPTIONS SURFACE	210mm x 146mm (Opt 1), Bracket 260mm (Opt 2) weight 1000gms
BEARING DETECTION METHOD	Triangular phase delta
BEARING RESOLUTION ACCURACY	±5° @ 10 dBuv/m maximum
OPERATING TEMPERATURE	-20°C to +55°C
ANTENNA	
ANTENNA BASE DIMENSIONS	550mm (H) x 350mm (W) — PVC Plastic
ANTENNA BASE WEIGHT	1100gms
ANTENNA POLE MOUNTING BKT	50mm Internal Dial
OPERATING TEMPERATURE	-20°C to +70°C
ANTENNA GAIN	1.4 dBi nominal
ANTENNA COAXIAL CABLE	Impedance: 75 Ω Capacitance 60pF / m Attenuation / 100 m: 20 dB @ 121.5 MHz Diameter: 7.2 mm Coaxial Type : Triple RG179B/U
GENERAL	
BANDWIDTH	25 KHz
MODULATION	AM for audio and ΦM for direction finding
PORTS	DC12V Power Cable (1m) Antenna Cable (up to 30m)
SENSITIVITY	3 dBuV/m (threshold of target bearing resolution)
FREQUENCIES	121.5 MHz (default), 121.65 MHz (Test 1), VHF programmable (Test 2)
CRITERIA OF EIT / BEACON RECOGNITION	Audible AM down-swept tone (compliant to ITU-R M.690-3)
AUDIO OUTPUT	¼" Jack socket for 15W, 8 Ohm external speaker
RELAY CONTACT	Floating, carrying capacity max. 2A @ 250 VAC maximum.
CURRENT CONSUMPTION	Off = 7 mA (typical) Standby = 500 mA (typical) Tracking = 550mA Alarming = 1000 mA (max, no external speaker) Alarming = 2000 mA (max, 8Ω external speaker)
OPERATING VOLTAGE	12V DC
IN LINE FUSE	3.15 A
DISPLAY	7" TFT LCD display



WESCOM GROUP, UNIT J1, ANLABY TRADE PARK, SPRINGFIELD WAY, ANLABY, HULL, HU10 6RJ

TEL: +44 (0)1482 679 300 | SMRT@WESCOM-GROUP.COM | WWW.SMRTSOS.COM